



Lifting jack

Typ: KAL 275

Order no. 12373



Structure and use guidance

The **m+ba** lifting jack serves for lifting or lowering components and loads with assembly works on building sites. Only vertical loads (in the plumb line) must be carried.

With the lifting jack e.g. steel girders or wood purlins can be millimeter-exactly aligned. The weight is turned up or down by means of crank within selflocking spindle transmission. The lifting jack is equipped with swivel rollers, so that it can be easily moved to the load bearing position when not carrying a load. When loaded, it must (only) be moved in longitudinal direction, which enables precise alignment of components.

General note

Only components in perfect status and original equipment may be used. This must be checked before use. The lifting jack must not be used until it has been repaired appropriately. The lifting jack is to be used only according to the intended purpose. Any other improper use is prohibited. The rules for the prevention of accidents are to be observed.

Technical data

lifting height.....1.10 - 2.75 m
 with adapter1.36 - 3.00 m
 light mass heading fork36 x 21 x 11.5 cm
 dimensions folded1.59 x 0.81 x 0.63 m
 load-bearing capacity600 kg
 (In case of paired operation 2 x 450 kg = 900 kg)
 weight86 kg
 crank, adjustable..... **Order no. 12361**
 adapter **Order no. 12374**

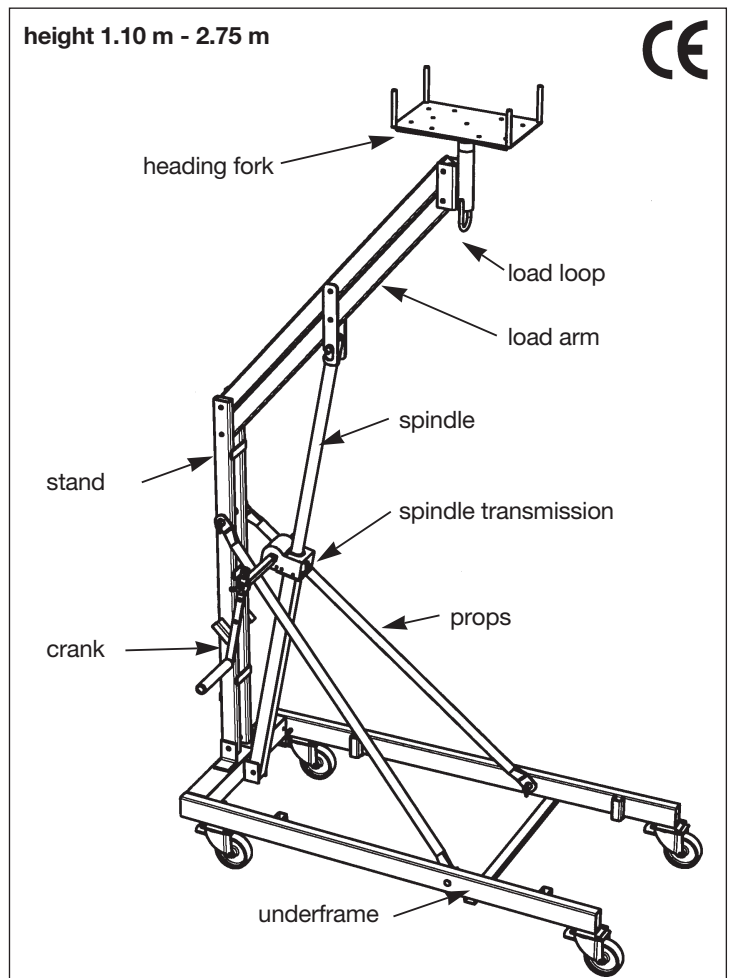
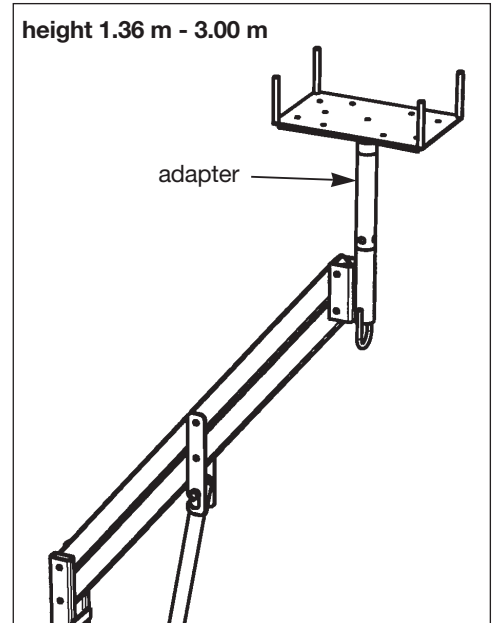

Building up the lifting jack

During erection and dismantling of the lifting jack, there is an increased risk of crushing for fingers and hands. The following steps should be performed by 2 people, and the components to be moved are to be touched and handled from the outside.

Do not reach into gaps and hinge openings.

Lifting jack in the folded down status.

Before building up all swivel rollers must be fixed with brakes.

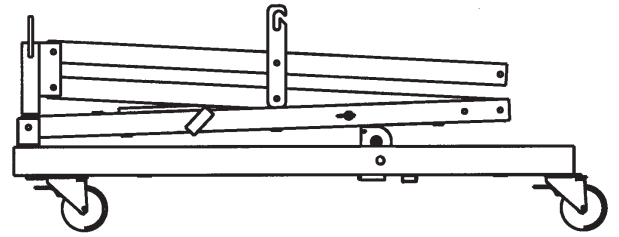

Caution, risk of crushing!

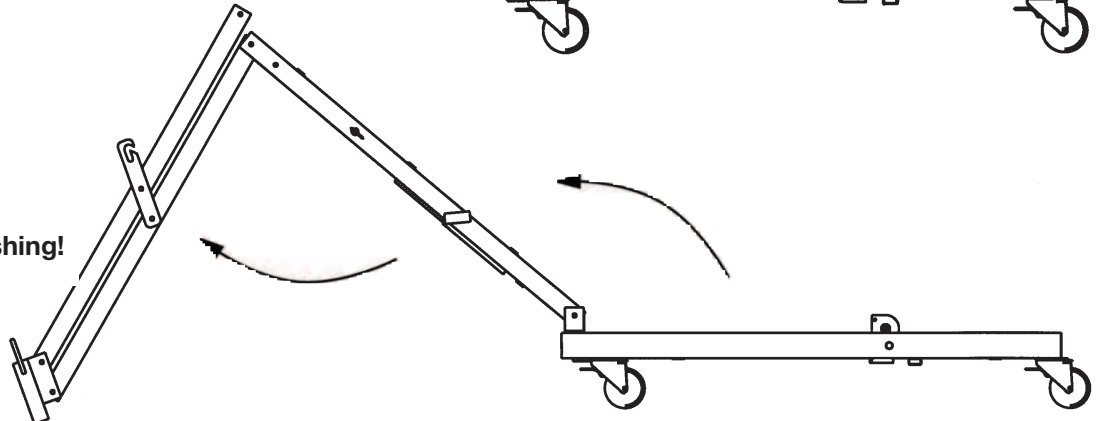

The load arms as well as the stand are folded up.

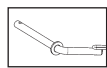

Locating pin

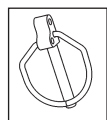

Quick lock pin

Subsequently, the load arm and the stand are connected with the locating pin. The locating pin becomes secured with the quick lock pin.

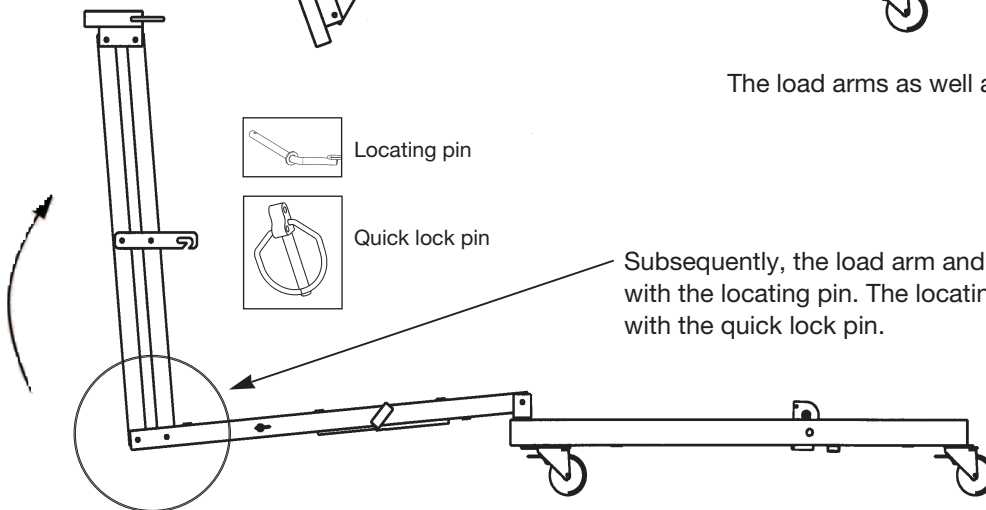

Now the stand is erected and fixed by attaching the struts onto the forked bolt on stand and carriage.

Caution, the boom is still freely movable and there is increased risk of crushing between the boom tubes!

Subsequently the spindle is swivelled up and introduced to the slot accommodation of the lateral strap of the load arm. Now the heading fork can be put in, even possible with adapter. The lifting jack is ready for action.

The disassembly takes place in reverse succession.



Caution, risk of crushing!

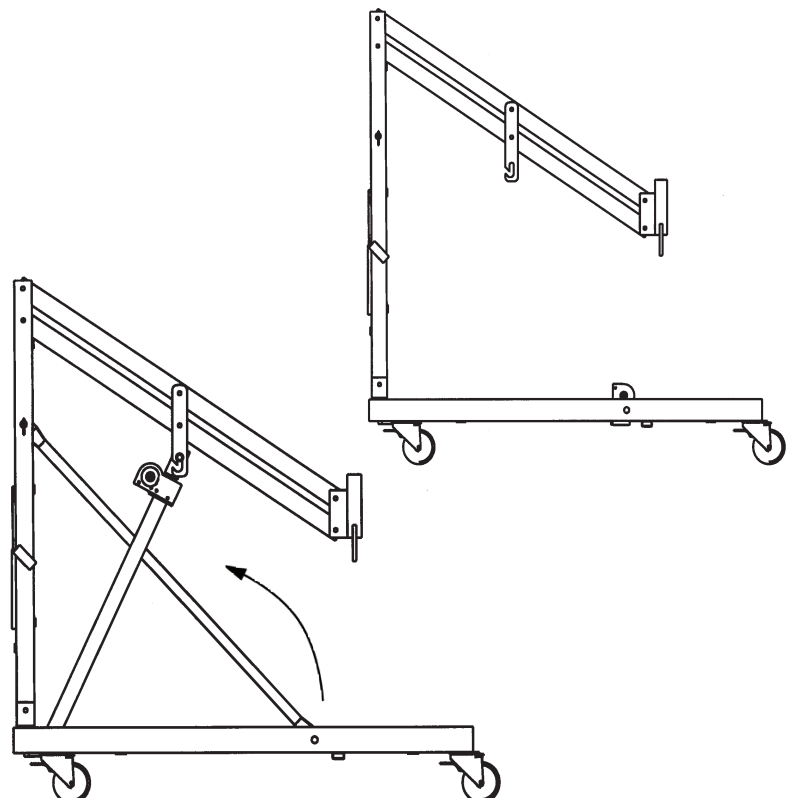

Use and operation

Important:

- The lifting jack may be set up only on horizontal-even, capable of foundation.
- The weight, e.g. a steel girder or a wood purlin, will be put on the heading fork of the lifting jack or hooked into the loop of the boom. The borings in the heading fork provide the possibility of fixing the hung up load.
- The brakes of the swivel rollers must be fixed beforehand. The swivel rollers should point to the outside once fixed, to realise maximum contact width.
- If loads placed or suspended are to be moved, this must be done in the deepest possible position of the boom. When moving with lifted load there is a risk of turning over!
- Moving with lifted load is only permissible in lifting jack longitudinal direction! Risk of turning over!
- It is recommended to sweep off the surface on which the lifting jack is moved under load. Even small stones hinder the swivel rollers of the loaded device.
- Another recommendation is to additionally secure the lifted load with scaffold jacks placed underneath during movement.
The crank for infinite lifting and lowering of the load can be attached on both sides of the spindle gear. Its length is adjustable, so that a large radius (lever arm) for lifting, or a small radius (faster) for unloaded movement can be set.

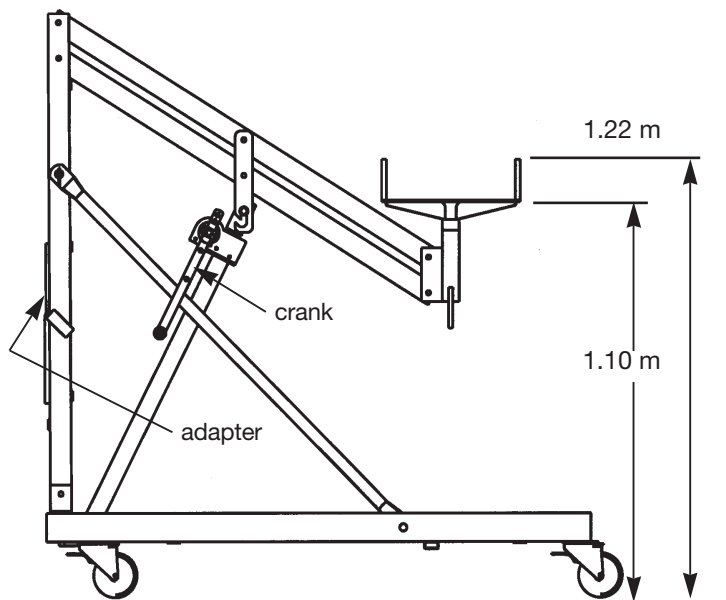
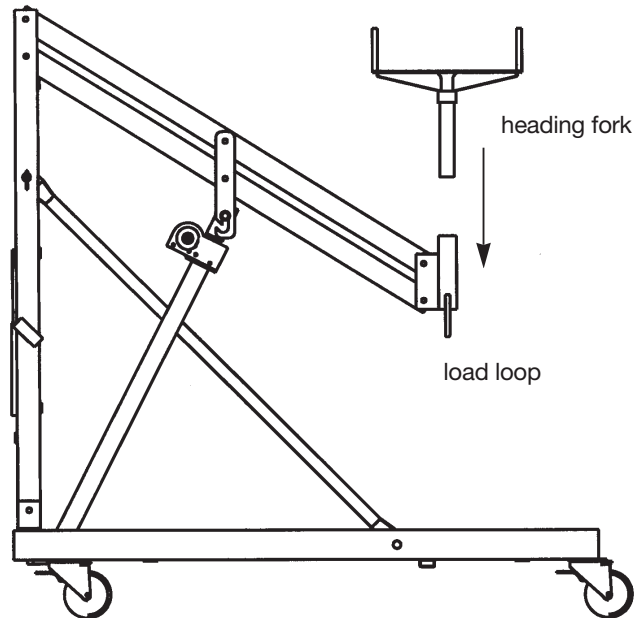

Caution, risk of crushing!

With the plug-on of the adapter, which is otherwise between the two pipes of the stand, it is possible to raise up the work height of the lifting jack by 0.25 m to 3.00 m.

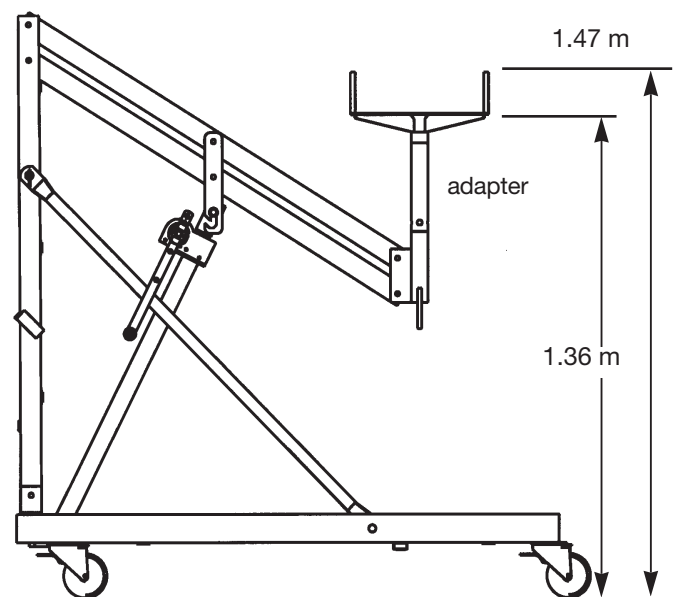

Lifting a load off the ground

A fundamental requirement for intended lifting with the lifting jack is the lifting jack carriage being below the load.

If the load to be lifted is on the ground (in the picture a carrier HE-B 300 for example), this must be initially lifted by approx. 30 cm and placed on a suitable base (e.g. squared timbers). This is the only way to ensure that the carriage of the lifting jack can move under the carrier for the actual lift.

Using one lifting jack

When working with one single lifting jack it is necessary to take up the carrier (or similar) to be lifted in the centre of gravity.

In this step the carrier is hooked into the load loop with respectively load-bearing sling gear to lift it to the respective height for take up by the

heading fork. This height depends on whether the heading fork is directly inserted into the mounting of the lifting jack or whether the adapter (order no. 12374) is used for a total lifting height of 3.0 m (see below). The lifted carrier is to be placed down on an appropriate load-bearing support (e.g. scaffold jacks).

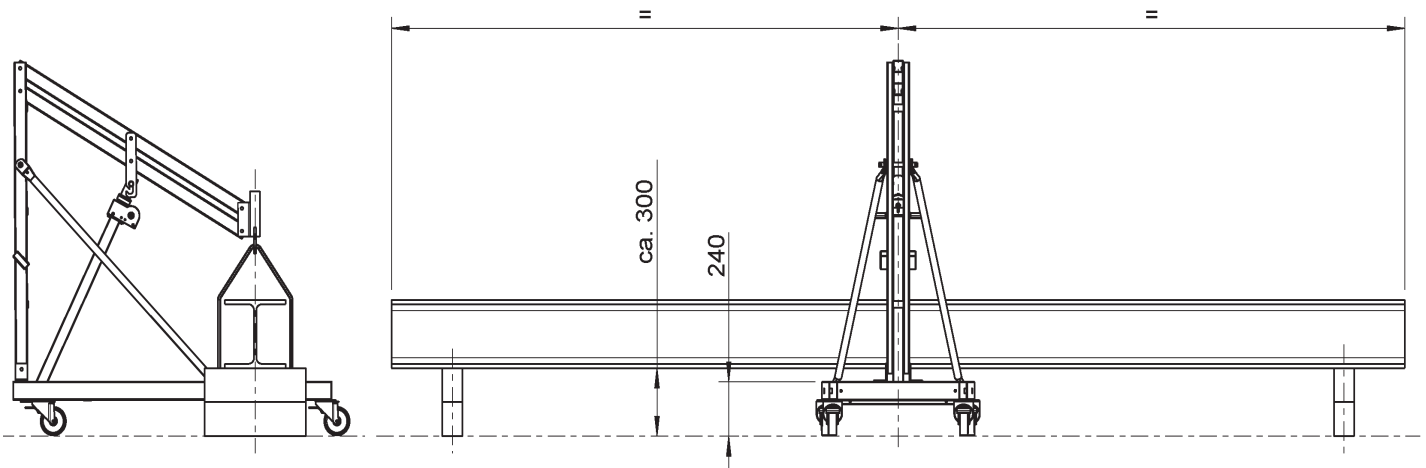
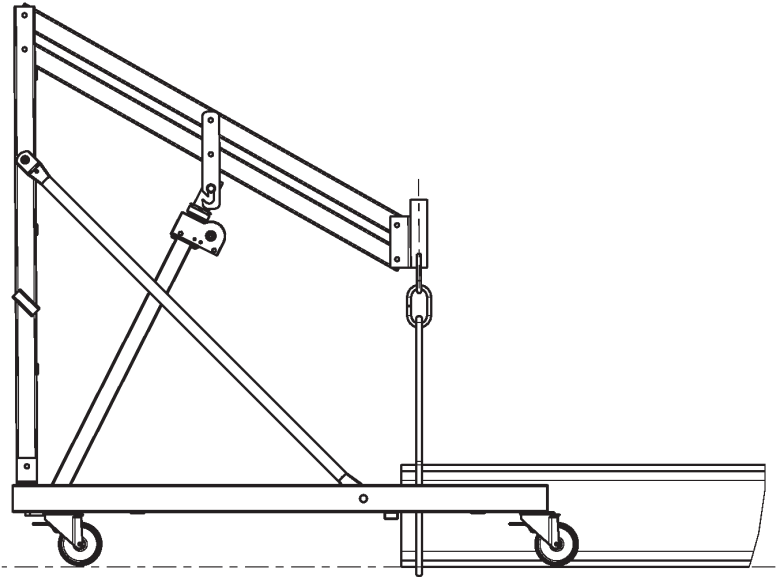

Once the heading fork and adapter, if required, are installed, the carrier (load) is to be lifted again in the centre of gravity. Borings in the plate of the heading fork enable additional mounting of the carrier. It is recommended during the lift to always track the support to provide an additional safety device against tilting and falling. The lifting jack must only be moved in its longitudinal direction with a lifted load!

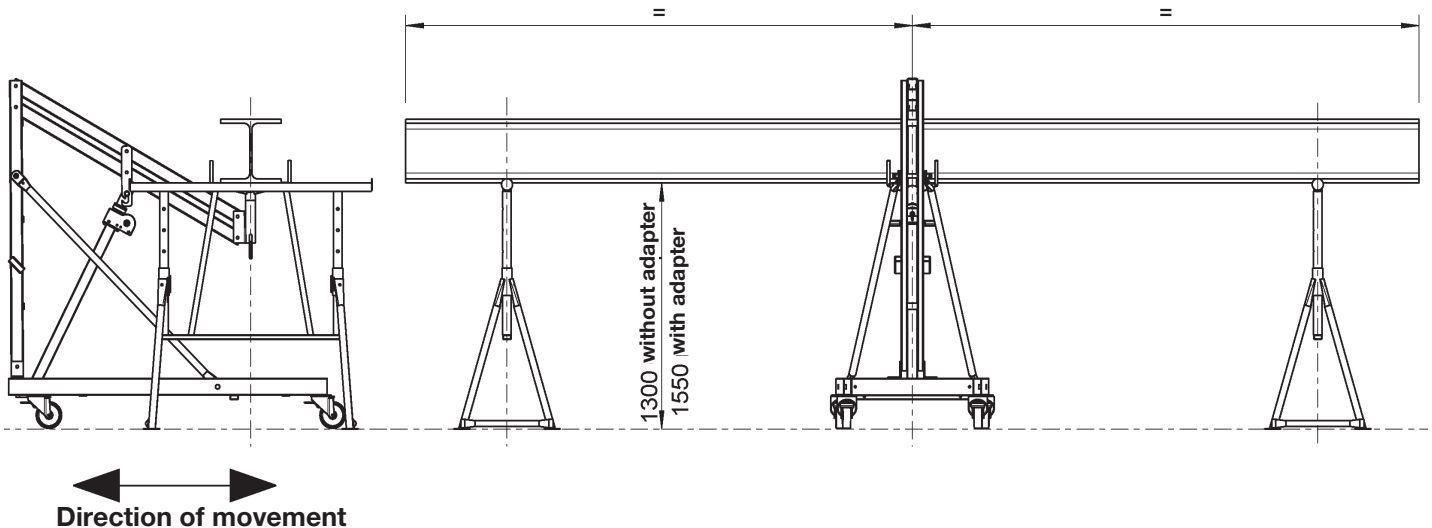

Using two lifting jacks

When using two lifting jacks in pairs, the maximum load bearing capacity increases to $2 \times 450 \text{ kg} = 900 \text{ kg}$

If two lifting jacks are being used, these are to be positioned symmetrical to the centre of gravity, as far towards the end of the carrier (load) as possible. Each lifting or lowering movement must be performed synchronously and uniformly, tilting of the carrier is to be avoided.

In this step the carrier is hooked into the load loops with respectively load-bearing sling gear to lift them to the respective height for take up by the heading fork. This height depends on whether the heading fork is directly inserted into the mounting of the lifting jack or whether the adapter (order no. 12374) is used for a total lifting height of 3.0 m (see below). The lifted carrier is to be placed down on an appropriate load-bearing support (e.g. scaffold jacks).

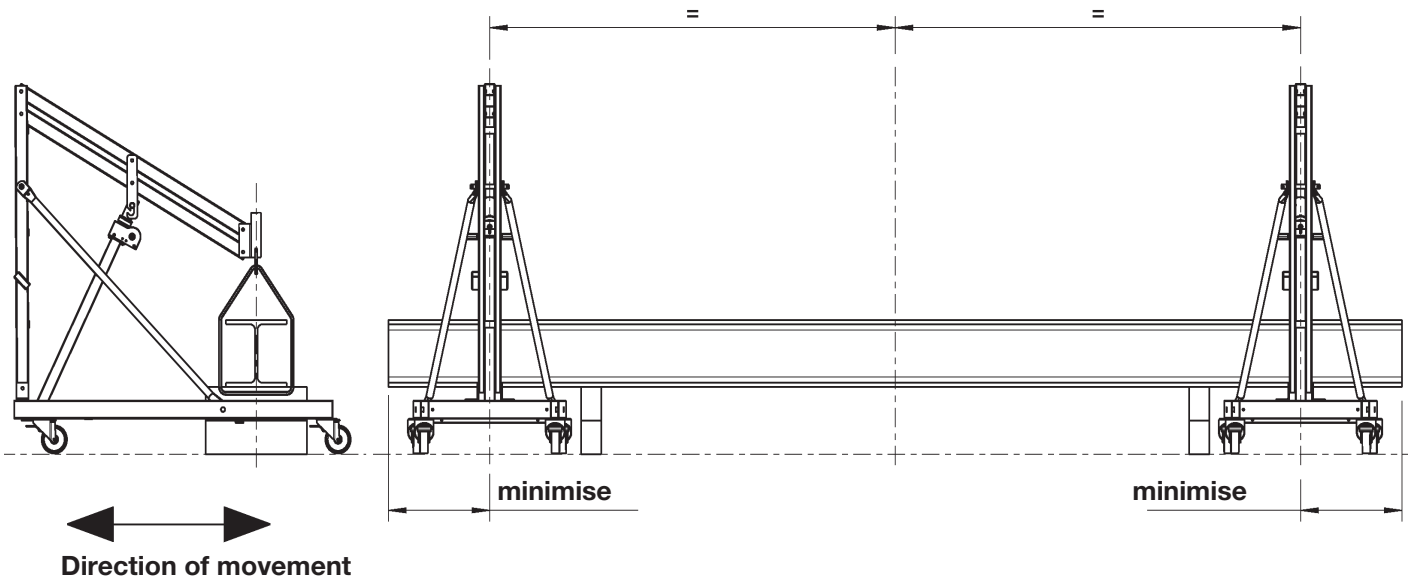

Once the heading fork and adapter, if required, are installed, the carrier (load) is to be lifted again **SYMMETRICAL** to the centre of gravity. Borings in the plates of the heading forks enable additional mounting of the carrier. It is recommended during the lift to always track the support to provide an additional safety device against tilting and falling. The lifting jacks must only be moved in their longitudinal direction with a lifted load!

Putting down the weight takes place in reverse succession.

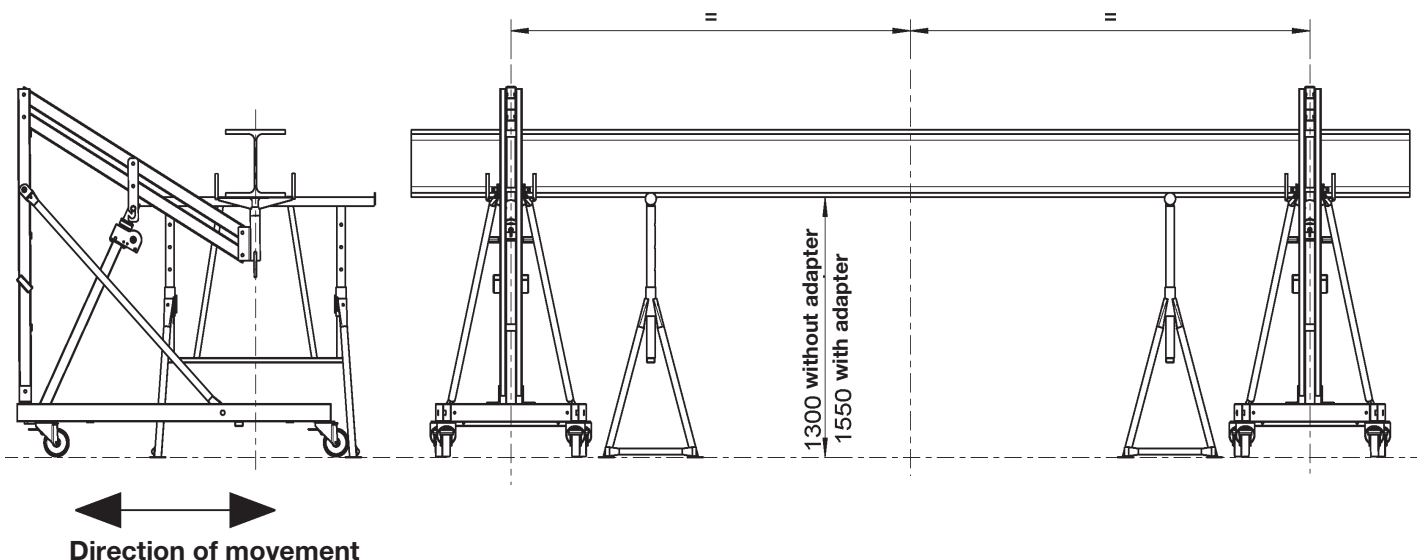

Before each employment is to be considered

- Visual check of the lifting jack on complete assembly and functional test of the spindle transmission.
- Defective or worn parts must be changed before using.
- Examine the spindle, the spindle transmission as well as the bearings for sufficient lubrication:

- lubricants of the spindle as well as the spindle transmission with machine fat



- oils of all bearings



Storing the lifting jacks

In the folded up status several lifting jacks could be stacked with the help of the plug-on handles (Order no. 12351) one above the other. Altogether max. 5 lifting jacks may be stacked one above the other.

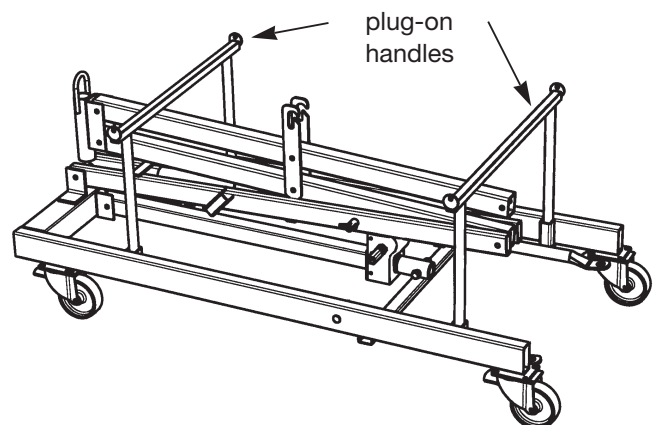
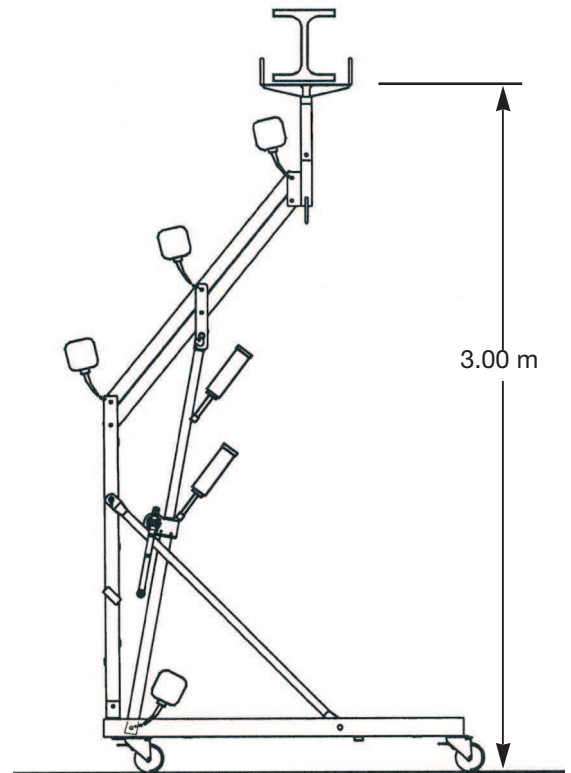
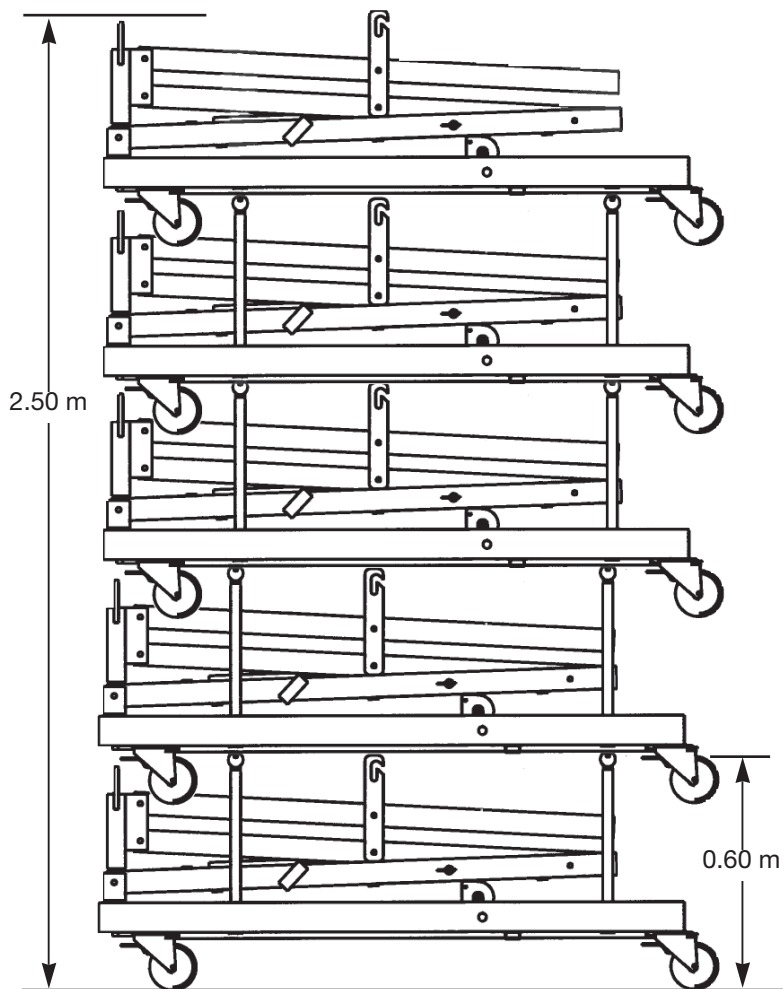

Technical subject to change 10.07.2014

Müller + Baum Baugerätefabrik GmbH & Co. KG

Birkenweg 52 · 59846 Sundern/Hachen · Postbox 2045 · 59837 Sundern/Hachen

Tel. +49 (0) 2935/801-0 · Fax. +49 (0) 2935/801-42 · www.mueba.de · E-mail: service@mueba.de